



the wetseat

neoprene seatcovers



a product of **INLAND**
AUSTRALIA PTY LIMITED



Like, Follow, Subscribe

facebook.com/thewetseat

instagram.com/thewetseat

thewetseat.com/fitting-care/

Important This seat cover suits the TOYOTA PRADO 150 Series GXL only



- Do not fit these seat covers to any other vehicle.
- Please read these instructions carefully and install seat covers exactly as described.
- Regularly inspect seat covers for any wear or misalignment which may cause damage to the seat covers.
- Adjust alignment if seat cover twists or moves from its original, centrally aligned position.
- As with all garment type products the threads will give if pulled on too hard. Use just enough force to align and pull the cover without breaking the sewn threads.
- Check that the cover does not impede the child restraint system or the seat belts and buckles.
- Place these fitting instructions in your glove box after installation for future reference.
- If you have any difficulty during installation, please call The Wet Seat office for help.

Care of your Wet Seat covers

For light marks and surface dirt a damp cloth, chamois or wet wipes will suffice.

For heavier marks and stains machine wash your Wet Seat,
Set to cold wash, gentle cycle using standard washing powder.

Dust off the covers first before putting them into a machine wash.

For salt water, sand or mud also try to hose down your Wet Seat, cloth line dry in 1 hour
(Ambient temp 20 degrees Celsius).

Kit Contents

- 2 x Tailored Backrest Wet Seat Cover (Driver & Passenger)
- 2 x Tailored Armrest Wet Seat Cover (Small & Large)
- 2 x Tailored Cushion Wet Seat Covers (60% & 40%)
- 3 x Tailored Headrest Wet Seat Covers (2 x Side & 1 x Ctr)



Contact Us



Inland Australia Pty. Ltd.
Unit 2/10c Childs Road.
Chipping Norton.
NSW. 2170. Australia



+61 2 9724 9499



sales@thewetseat.com



www.thewetseat.com

The Wet Seat™ Neoprene Seat Covers

The Wet Seat neoprene seat cover is a wet suit for your car seats. These innovative covers are designed for fitting onto all passenger vehicles. Catering for all seat types, so whether it is a 4x4, ute or the family wagon, The Wet Seat is a versatile cover designed for the Australian way of life.

The Wet Seat is:

- UV Safe, Wont fade in the sunny Australian conditions
 - Water Resistant, Perfect for the beach, water sports, water crossings, fishing, camping, touring and more!
 - Dust, Dirt, Sand & Mud Resistant, wont let any of these seep through to your seat keeping your seats clean & dry!
 - Superior Comfort & Aesthetically Appealing
 - Abrasion and Chemical Resistant
 - Non Soiling and Non Static, Simple removal of dust and pet hair
- Australia's most trusted neoprene seat cover since 2007.

The Wet Seat Neoprene Seat Covers - www.thewetseat.com

TAILORED BACKREST COVER INSTALLATION

1. Remove all 3 headrests (Fig. 1).

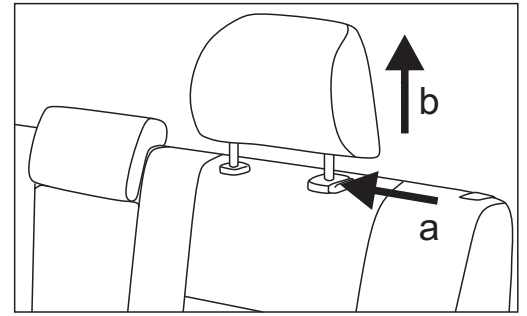

Fig. 1

2. Tilt seat backrest forward. Place backrest cover over the seat backrest, feeding through the middle seat belt. (Fig. 2)

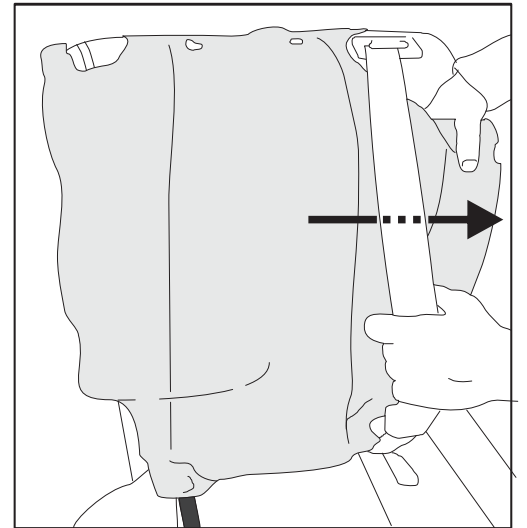

Fig. 2

3. Using your fingers, push backrest cover under headrest guide mechanisms to hold the top part of the backrest cover in place and centrally aligned (a). (Fig. 3)

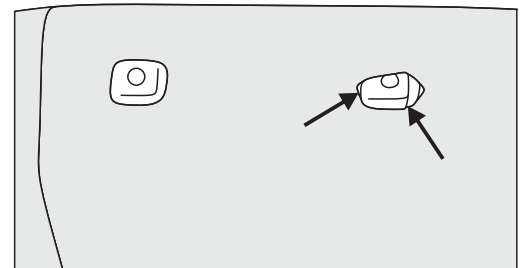

Fig. 3

4. For best fitment, work the backrest evenly and keep it aligned to the seats contours at all times. Once aligned, fold backrest forward and push the middle parts of the backrest cover through in between the seat backrest and base. (Fig. 4)

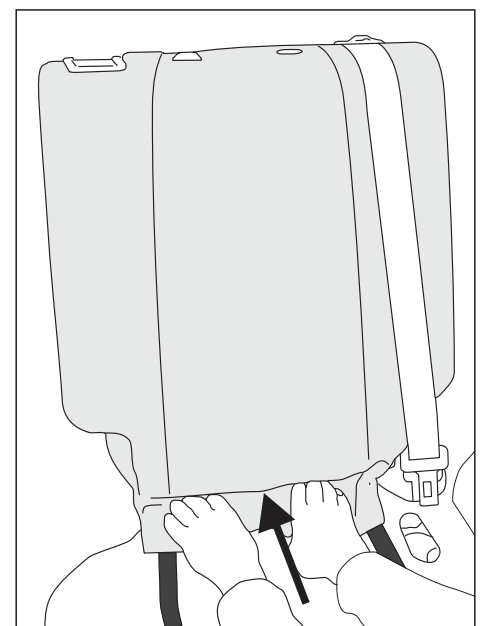

Fig. 4

5. From the rear of the seat pull middle part of the backrest cover all the way through ensuring a tight fit.
(Fig. 5)

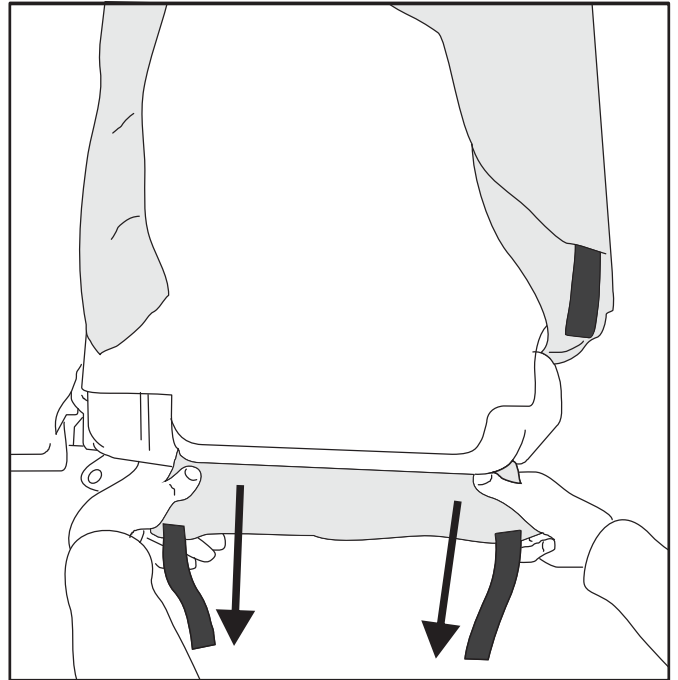

Fig. 5

6. Attach the 2 loop tapes to the 2 hook tapes inside the back corners of the backrest cover.
(Fig. 6)

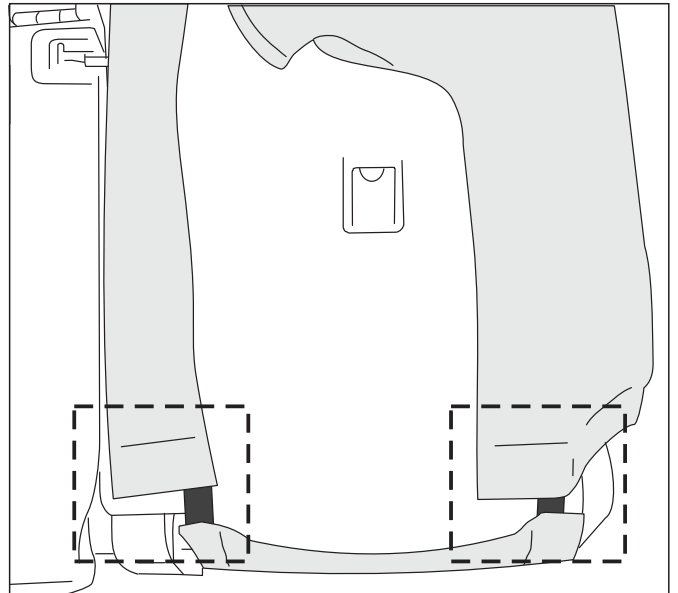

Fig. 6

7. At the top of the backrest, secure top hook and loop tapes. Also, ensure the seat belt mechanism and the seat release latch is clear of the seat cover.
(Fig. 7)

Repeat Steps 2-7 for other backrest cover.

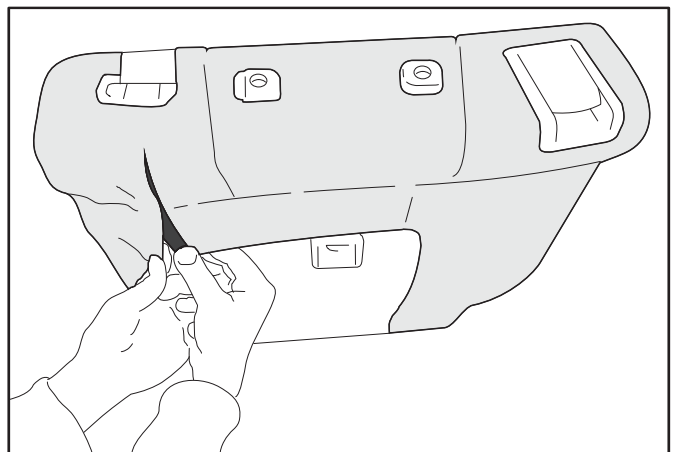

Fig. 7

TAILORED ARMREST COVER INSTALLATION

8. Tilt armrest forward. Turn the armrest cover inside out, align it to the top of the armrest and roll the cover over (Fig. 8).
9. Push bottom part of armrest cover through to the back (Fig. 9).

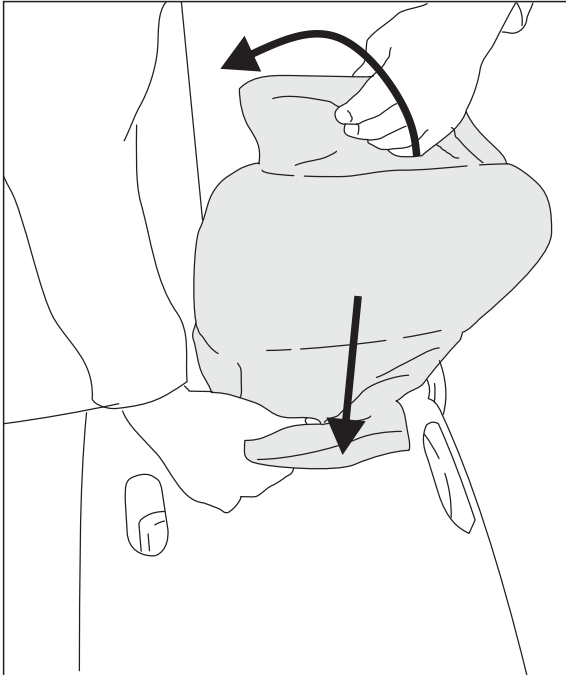

Fig. 8

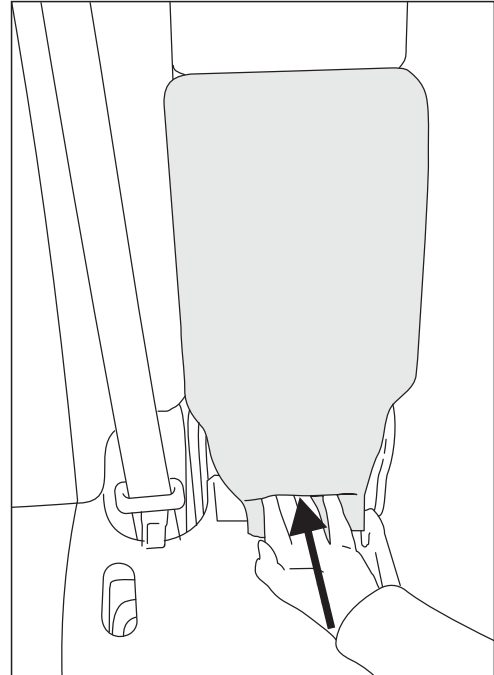

Fig. 9

10. Pull bottom part of armrest cover and secure the hook and loop tapes. (Fig. 10)

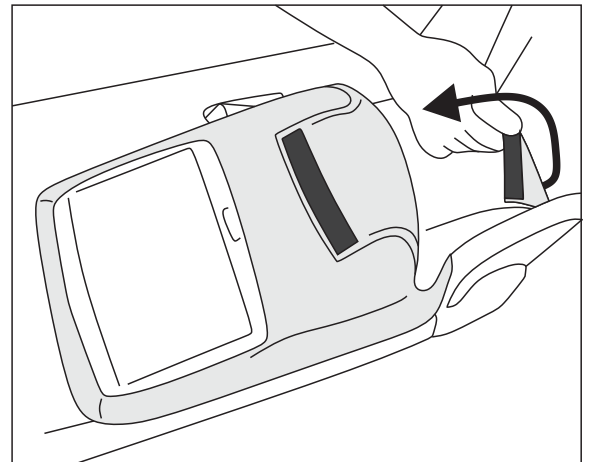

Fig. 10

11. For the small independent part of the seat below the armrest, fold armrest down and locate the small cover for this part. Place cover over the small part and feed through to the back and attach the hook and loop tapes. (Fig. 11)

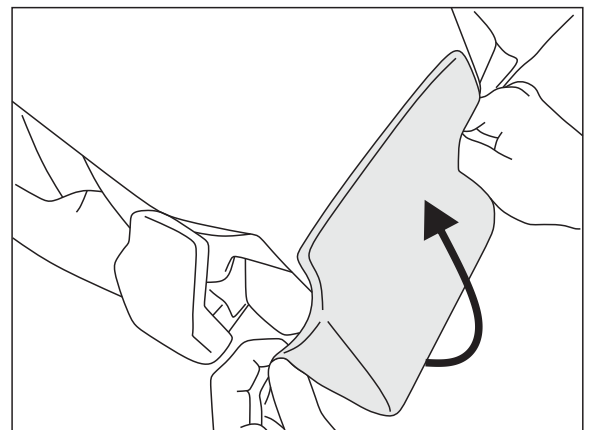

Fig. 11

TAILORED BASE COVER INSTALLATION

12. Align the larger base cover to the seats contours and roll around the edge of the seat. Push the middle parts of the base cover through in-between the seat base and backrest. (Fig. 12)

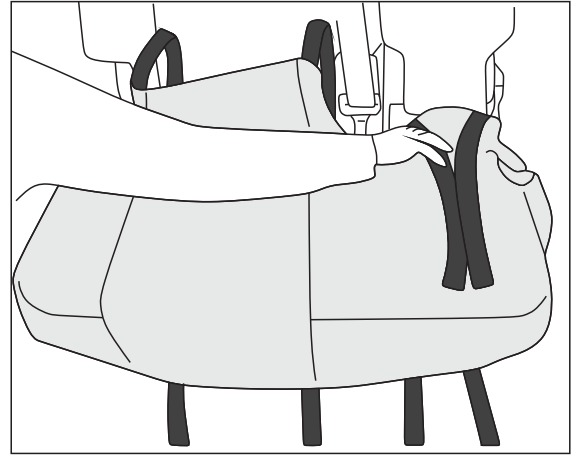

Fig. 12

13. On the outside of the seat base, wrap cover under and around the seat adjustment lever. Attach the hook and loop tapes directly under the lever. (Fig. 13)

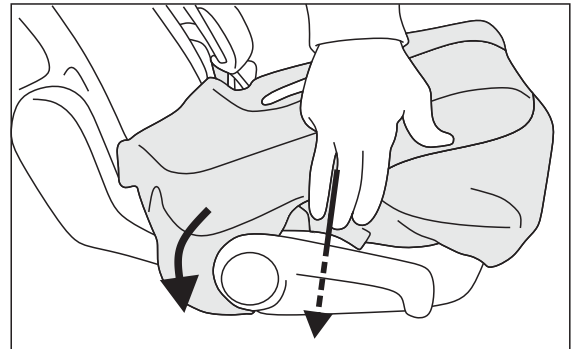

Fig. 13

14. Secure all corresponding hook and loop tapes under the seat, avoiding all mechanical levers and actuators. Also attach the hook tape on the back inside corner to the carpeted underside of the seat base. Check that the seat can freely slide back and forward. (Fig 14)

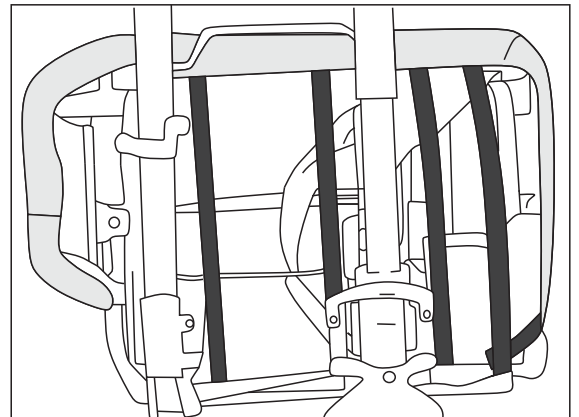

Fig. 14

15. Align the smaller base cover to the seats contours and roll around the edge of the seat. Push the middle parts of the base cover through in-between the seat base and backrest. (Fig. 15)

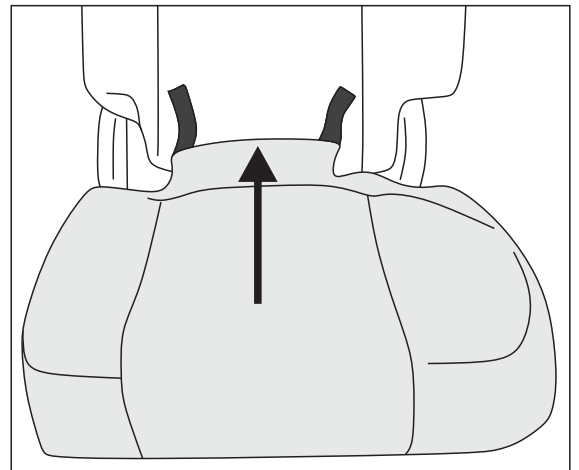

Fig. 15

16. Pass the rear inside loop tape around the back of the seat rail guide to the back of the seat and attach it to the carpeted part under the seat.
(Fig. 16)

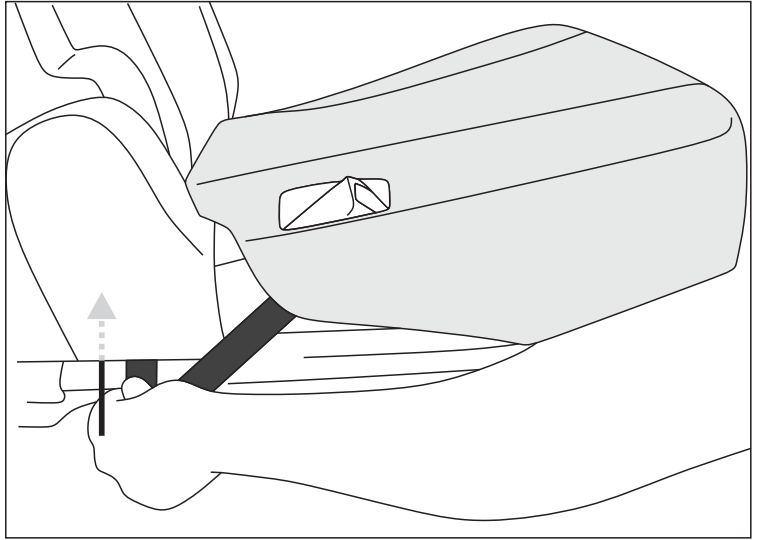

Fig. 16

17. On the outside of the seat base, wrap cover under and around the seat adjustment lever. Attach the hook and loop tapes directly under the lever.
(Fig. 17)

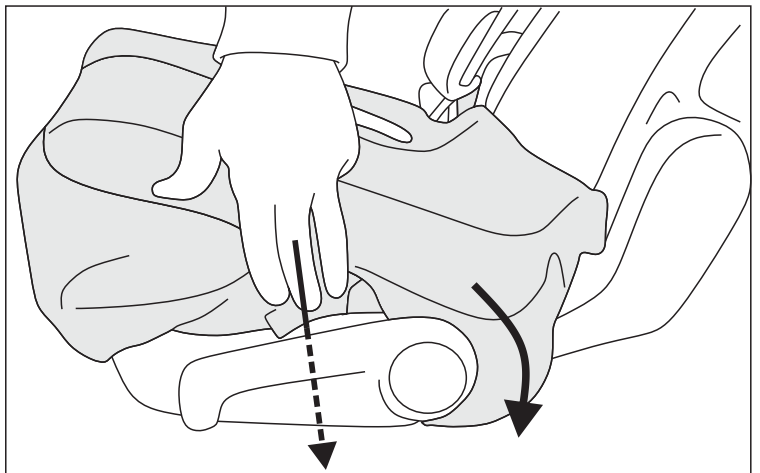

Fig. 17

18. Secure all corresponding hook and loop tapes under the seat, avoiding all mechanical levers and actuators. Check that the seat can freely slide back and forward.
(Fig. 18)

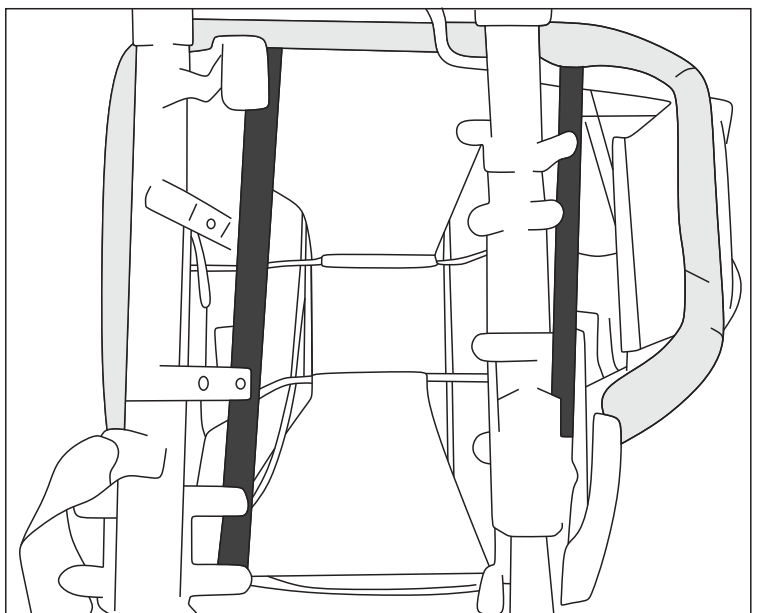

Fig. 18

TAILORED HEADREST COVER INSTALLATION

19. Turn the headrest covers inside out and lay upside down on top of the headrest. Proceed to wrap the headrest cover over the headrest by rolling it down evenly. To make sure the headrest cover is being fitted correctly, ensure the seams are aligned before rolling it down. Once fitted, attach the hook and loop tapes underneath.
(Fig. 19)

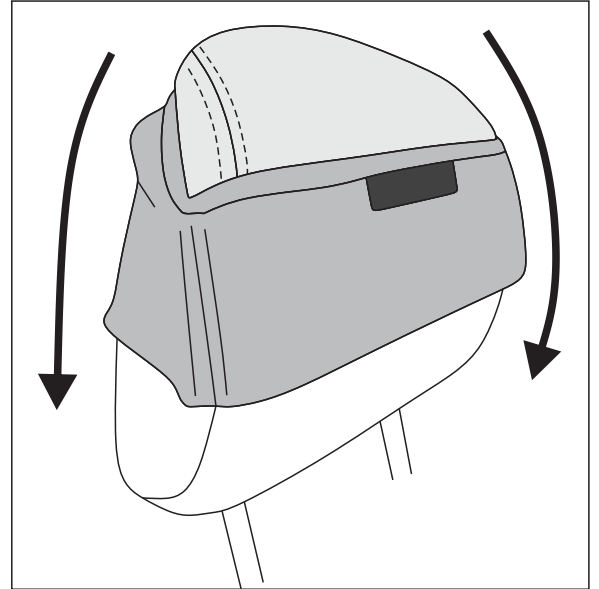

Fig. 19

20. To install the centre headrest cover, wrap the cover over the headrest from the back to the front keeping it aligned at all times.
(Fig. 20)

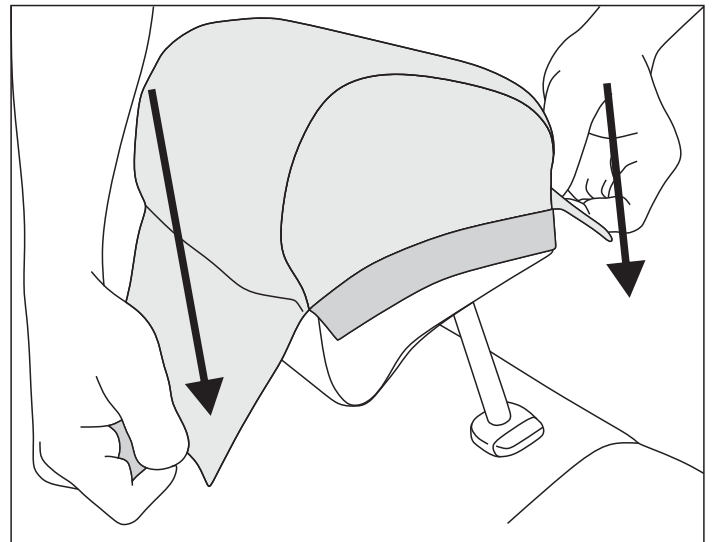

Fig. 20

21. Attach the hook and loop tapes underneath.
(Fig. 21)

22. Re-install all 3 headrests to the seat backrest.

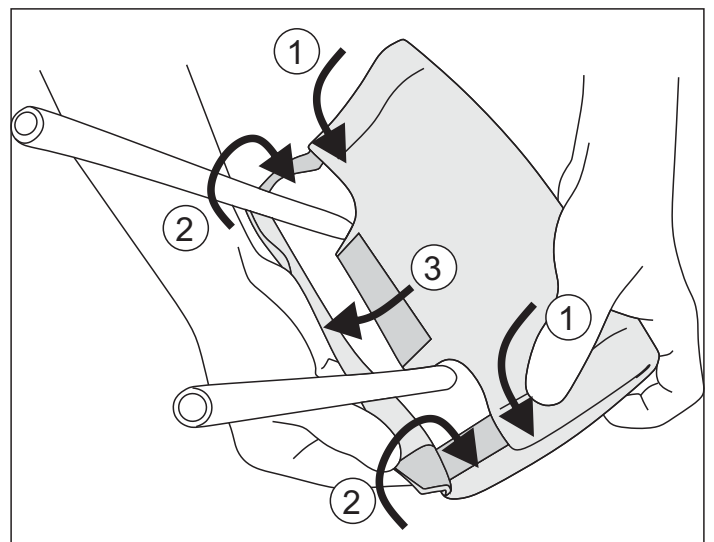

Fig. 21